

### Features

- 3.2mmx1.0mm RIGHT ANGLE SMT LED, 1.5mm THICKNESS.
- LOW POWER CONSUMPTION.
- WIDE VIEWING ANGLE.
- PACKAGE : 2000PCS / REEL.
- MOISTURE SENSITIVITY LEVEL : LEVEL 3.
- RoHS COMPLIANT.



### Notes:

1. All dimensions are in millimeters (inches).
2. Tolerance is  $\pm 0.1(0.004)$  unless otherwise noted.
3. Specifications are subject to change without notice.

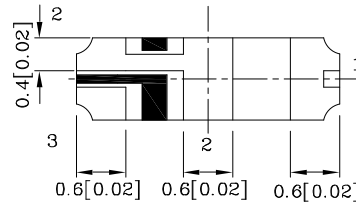
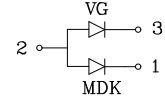
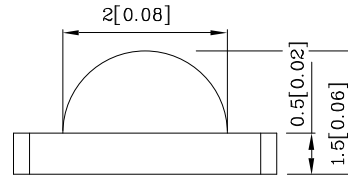
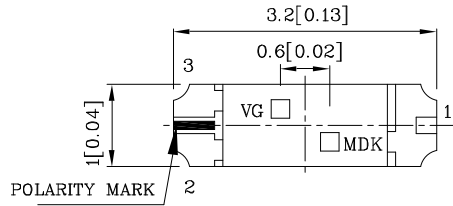

Absolute Maximum Ratings (TA=25°C)		MDK (InGaA IP)	VG (InGaA IP)	Unit
Reverse Voltage	V <sub>R</sub>	5	5	V
Forward Current	I <sub>F</sub>	30	30	mA
Forward Current (Peak) 1/10Duty Cycle 0.1ms Pulse Width	i <sub>FS</sub>	185	150	mA
Power Dissipation	P <sub>T</sub>	75	75	mW
Operating Temperature	T <sub>A</sub>	-40 ~ +85		°C
Storage Temperature	T <sub>stg</sub>	-40 ~ +85		

Operating Characteristics (TA=25°C)		MDK (InGaA IP)	VG (InGaA IP)	Unit
Forward Voltage (Typ.) (I <sub>F</sub> =20mA)	V <sub>F</sub>	1.95	2.1	V
Forward Voltage (Max.) (I <sub>F</sub> =20mA)	V <sub>F</sub>	2.5	2.5	V
Reverse Current (Max.) (V <sub>R</sub> =5V)	I <sub>R</sub>	10	10	uA
Wavelength Of Peak Emission (Typ.) (I <sub>F</sub> =20mA)	λ <sub>P</sub>	650	574	nm
Wavelength Of Dominant Emission (Typ.) (I <sub>F</sub> =20mA)	λ <sub>D</sub>	635	570	nm
Spectral Line Full Width At Half-Maximum (Typ.) (I <sub>F</sub> =20mA)	Δλ	28	20	nm
Capacitance (Typ.) (V <sub>F</sub> =0V, f=1MHz)	C	35	15	pF

Part Number	Emitting Color	Emitting Material	Lens-color	Luminous Intensity (I <sub>F</sub> =20mA) mcd		Wavelength nm λ <sub>P</sub>	Viewing Angle 2 θ 1/2
				min.	typ.		
ZMDKVG88W	Red	InGaAlP	Water Clear	110	198	650	120°
	Green	InGaAlP		18	49		

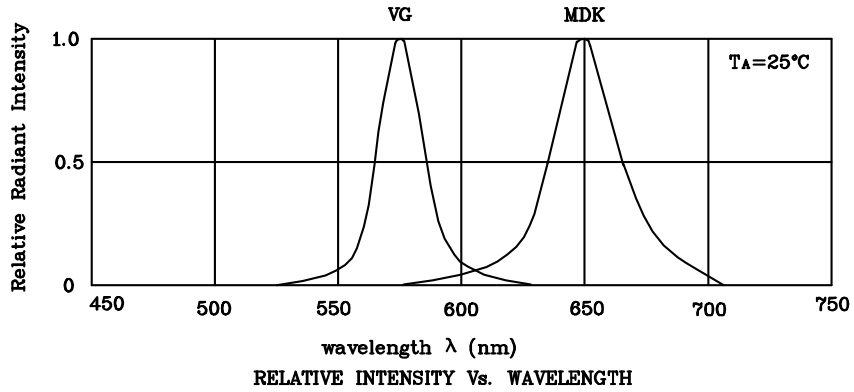

❖ MDK

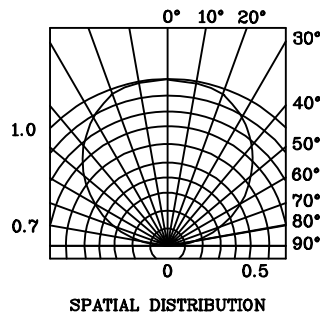
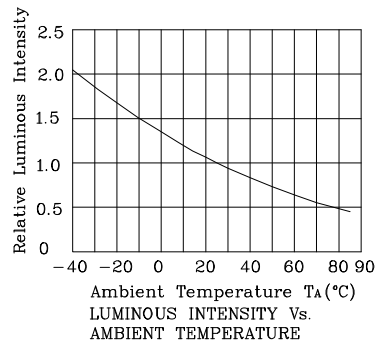
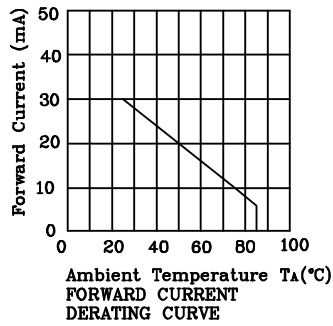
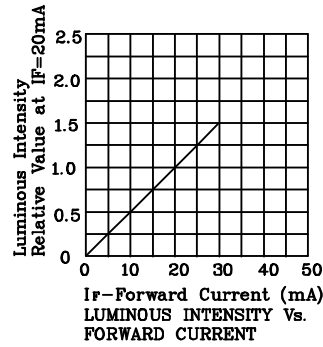
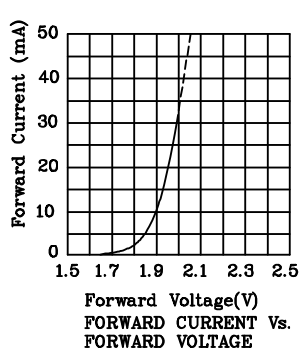

❖ VG

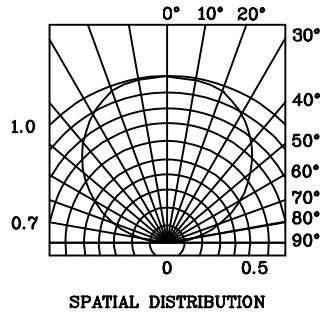
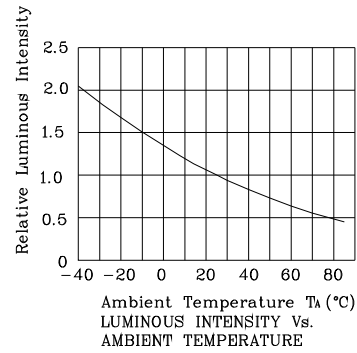
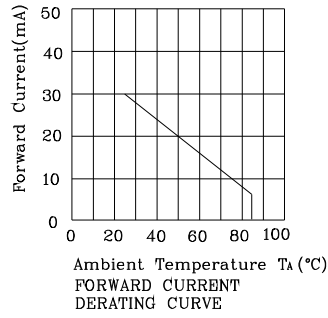
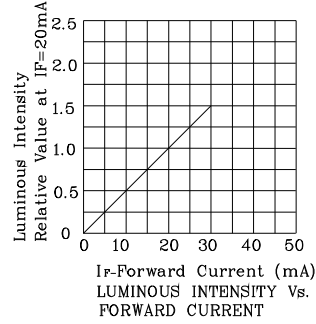
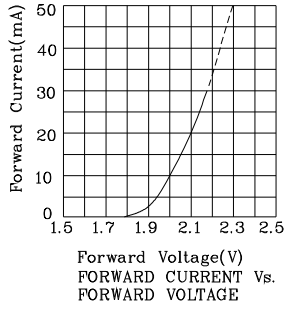

Reflow Soldering Profile For Lead-free SMT Process.

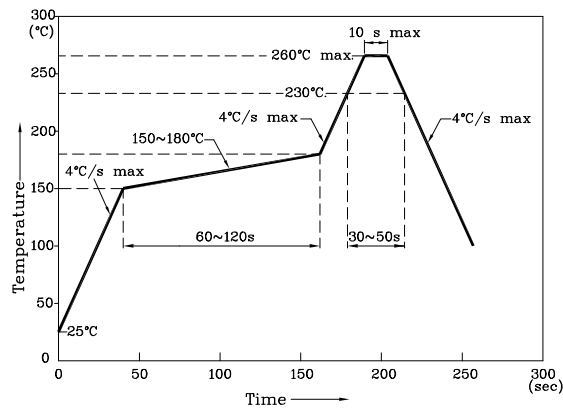

NOTES:

1. Maximum soldering temperature should not exceed 260°C.
2. Recommended reflow temperature: 145°C-260°C.
3. Do not put stress to the epoxy resin during high temperatures conditions.

❖ Recommended Soldering Pattern  
(Units : mm; Tolerance: ±0.1)

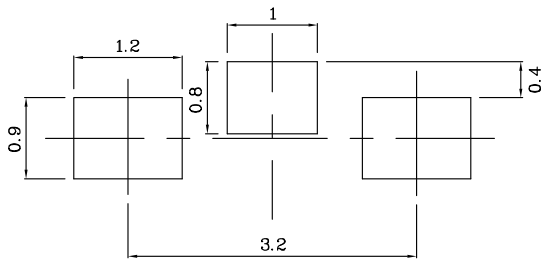

❖ The device has a single mounting surface. The device must be mounted according to the specifications.

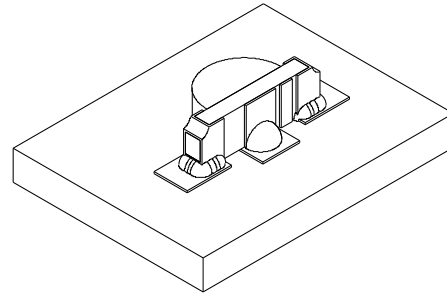

❖ Tape Specification (Units : mm)

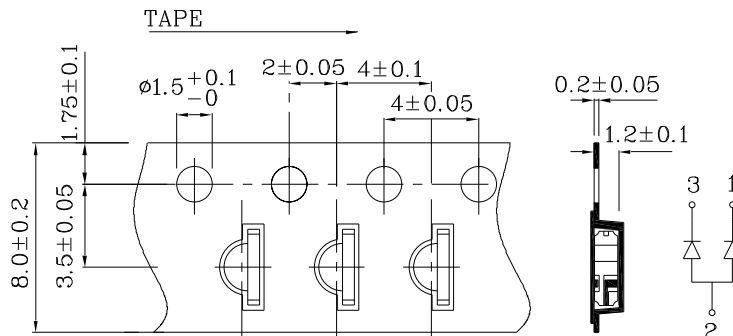

Remarks:

If special sorting is required (e.g. binning based on forward voltage, Luminous intensity / luminous flux, or wavelength), the typical accuracy of the sorting process is as follows:

1. Wavelength: +/-1nm
2. Luminous intensity / luminous flux: +/-15%
3. Forward Voltage: +/-0.1V

Note: Accuracy may depend on the sorting parameters.

**PACKING & LABEL SPECIFICATIONS**

**ZMDKVG88W**

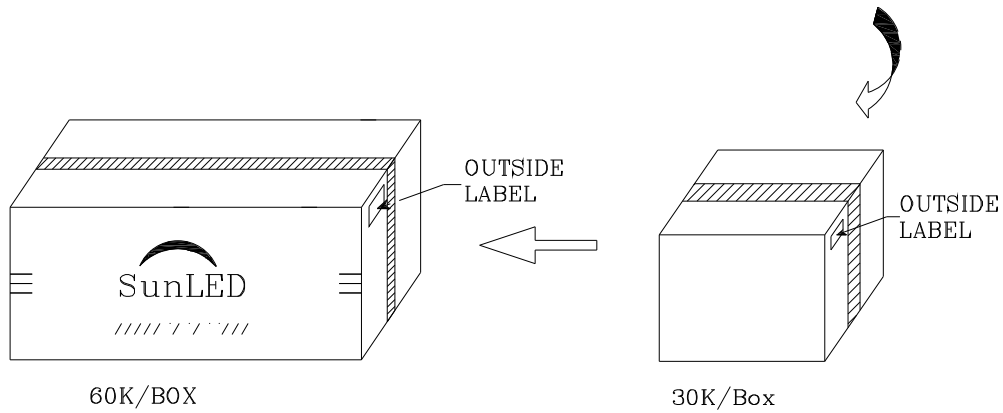
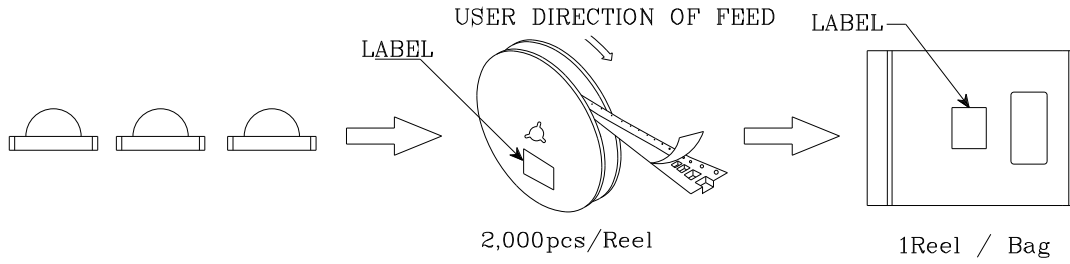

P/NO : Zxxx88x	
QTY : 2,000 pcs	CODE: XXX
S/N : XX	
LOT NO:	
 XXXXXXXXXXXXXXXXXXXXX	
RoHS Compliant	